



AZIENDA CERTIFICATA

 [®] SCAFFALATURE - LOGISTICA INTEGRATA
BIZZOTTO SRL

KIT METALLICI PER PASSIONE

MADE IN ITALY



dal 1974 ad oggi

1974

Bizzotto Carpenteria Metallica (Rosà)



1976

Inizia la produzione del primo KIT



1994

Metaltre Srl
 Società commerciale del gruppo



2002

Bizzotto Inaugura la nuova e funzionale sede produttiva



2011

Implementazione CRM
 Migliori software di progettazione



2007

Bizzotto Certifica la propria qualità secondo la norma ISO 9001:2000



2006

Coils Block, brevetto industriale per lo stoccaggio delle bobine



2012

Bizzotto si espande in nuovi mercati



2013

Bizzotto diventa centro di trasformazione certificato UNI EN 1090 - EN 3834



2014

Bizzotto brevetta la linea B110



2016

Bizzotto ottiene la certificazione TÜV Rheinland



Fin dal 1974 l'attività della società Bizzotto Scaffalature srl inizia il proprio sviluppo nel settore della carpenteria medio-pesante per poi abbracciare quello della scaffalatura con a capo l'attuale amministratore Bizzotto Giuseppe. Oggi dopo gli importanti successi e traguardi produttivi raggiunti, la società Bizzotto grazie al know-how acquisito ed al successo delle soluzioni altamente innovative introdotte, costruisce su propria licenza scaffalature per la logistica integrata destinati allo stoccaggio, rispettando le direttive sulla sicurezza e della funzionalità. L'azienda, estesa su una superficie di 10.000 metri quadrati, occupa 40 dipendenti.

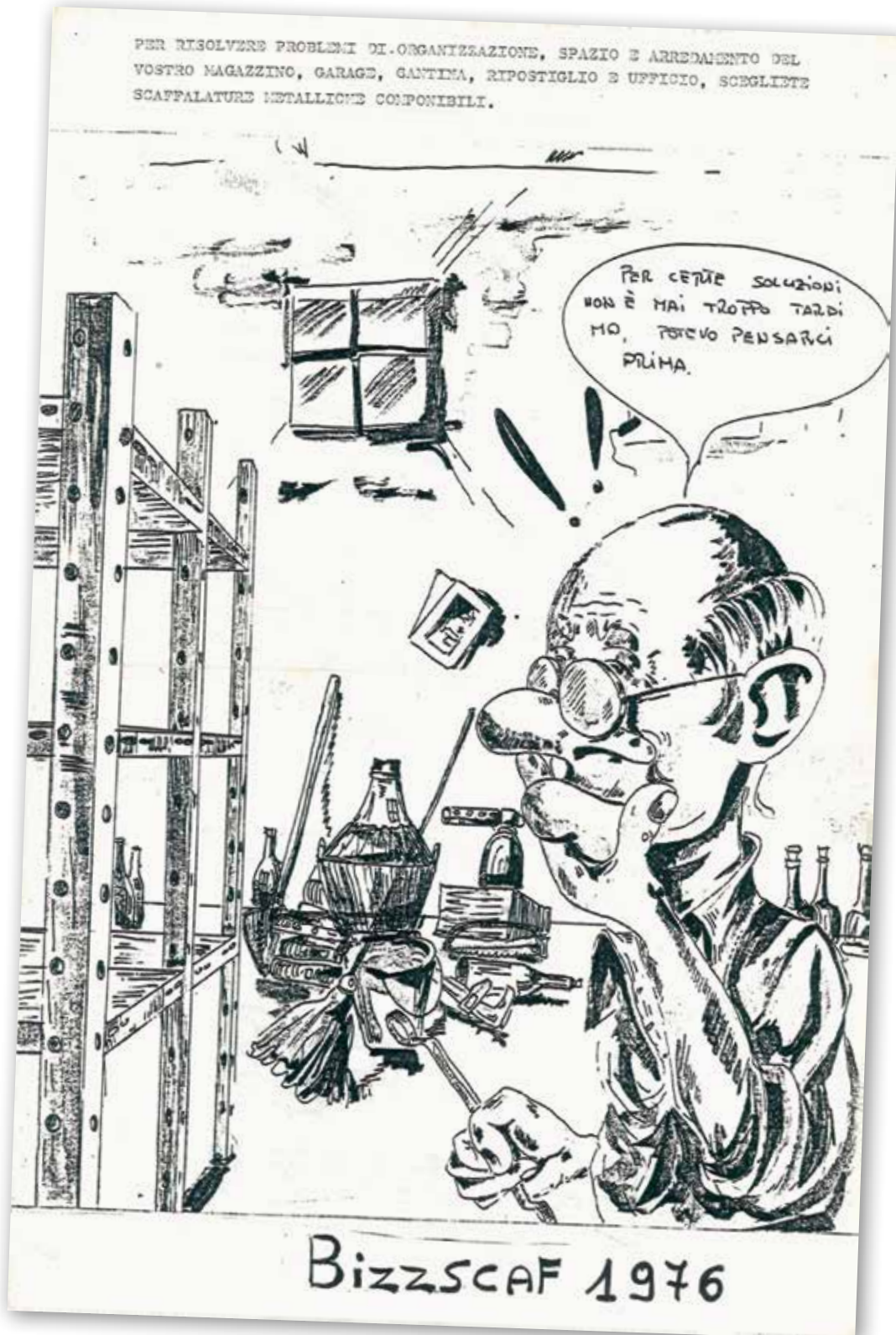

Kg
750

CAPACITÀ MASSIMA
DI CARICO

Kg
150

PORTATA PER PIANO
peso distribuito

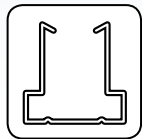

1111208570

IL KIT COMPRENDE:

- 8 montanti
- 6/8 traversini
- 5 piani rinforzati
- 20 ganci
- 4 piedini
- 4 giunti
- 1 crociera



COLORI DISPONIBILI

grigio ral 7038

art. **B300G**

PIANO

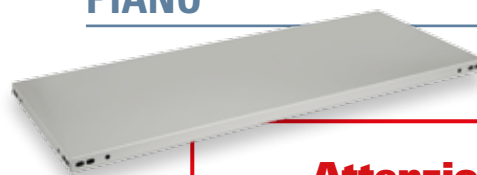

Attenzione!

Tutti i piani sono compatibili
per le scaffalature di nostra
produzione A BULLONE, LB1, LB6
vedi pagina 19

Montaggio rapido

articolo	dim. LxP (mm)	rinforzi	H (mm)	portata Kg	pezzi per pallet	pallet LxPxH (mm)
LB1-S8030G	800x300	SR	1600	100	48	1000x1200x2190
LB1-S8040G	800x400	R1	1600	150	40	1000x1200x2350
LB1-S8050G	800x500	R1	1600	150	32	1000x1200x2310

articolo	dim. LxP (mm)	rinforzi	H (mm)	portata Kg	pezzi per pallet	pallet LxPxH (mm)
LB1-S10030G	1000x300	R1	2000	130	42	1000x1200x2190
LB1-S10040G	1000x400	R1	2000	150	35	1000x1200x2350
LB1-S10050G	1000x500	R1	2000	150	28	1000x1200x2310

articolo	dim. LxP (mm)	rinforzi	H (mm)	portata Kg	pezzi per pallet	pallet LxPxH (mm)
LB1-S12030G	1200x300	R1	2400	130	42	1200x1200x2190
LB1-S12040G	1200x400	R1	2400	130	35	1200x1200x2350
LB1-S12050G	1200x500	R1	2400	130	28	1200x1200x2310



**Kg
500**

**CAPACITÀ MASSIMA
DI CARICO**

**Kg
100**

PORTATA PER PIANO
peso distribuito

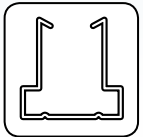

1111208570

IL KIT COMPRENDE

- 8 montanti da mm 900
- 6 traversini da mm 320
- 5 piani da mm 1000x400 rinforzati
- 20 ganci
- 4 piedini in PVC
- 4 giunti
- 1 crociera



COLORI DISPONIBILI



grigio ral 7038
art. LB1- 100G



bianco ral 9003
art. LB1- 100B



azzurro ral 5015
art. LB1- 100A



viola Pan. 2573C
art. LB1- 100V



verde ral 6018
art. LB1- 100VE



giallo ral 1018
art. LB1- 100Y



antracite ral 7016
art. LB1- 100AN



Scaffalatura ad incastro Montaggio rapido

EuroStock



art. E600Z/250

art. E600Z/175

Kg
1250

CAPACITÀ MAX
DI CARICO

Kg
875

CAPACITÀ MAX
DI CARICO

Kg
250

PORTATA
PER PIANO
peso distribuito

Kg
175

PORTATA
PER PIANO
peso distribuito

1800



IL KIT COMPRENDE

- Struttura in acciaio zincato
- 8 montanti 960 mm
- 5 piani in legno truciolare 1000x400 mm
- 4 piedini in PVC

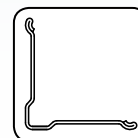

1111208570

COLORI DISPONIBILI

zincato

Eurostock 250 kg



Eurostock 175 kg



**Kg
350**

**CAPACITÀ MASSIMA
DI CARICO**

**Kg
70**

PORTATA PER PIANO
peso distribuito

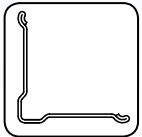

1111208570

IL KIT COMPRENDE:

- 8 montanti da mm 960
- 5 piani da mm 1000x400 rinforzati
- 4 piedini in pvc
- 1 tavoletta di legno



COLORI DISPONIBILI



Scaffalatura a gancio Montaggio rapido

MiniEuro



IL KIT COMPRENDE:

- 4 montanti da mm 1500
- 4 piani da mm 750x300
- 4 piedini in pvc
- 1 tavoletta in legno

Kg
160

CAPACITÀ MASSIMA
DI CARICO

Kg
40

PORTATA PER PIANO
peso distribuito

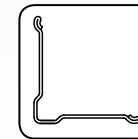

1111208570

COLORI DISPONIBILI



grigio ral 7038
art. E550G



bianco ral 9003
art. E550B



giallo ral 1018
art. E550Y



nero ral 9004
art. E550N



rosso ral 3020
art. E550R

96
PEZZI



Kg
350

CAPACITÀ MASSIMA
DI CARICO

Kg
70

PORTATA PER PIANO
peso distribuito

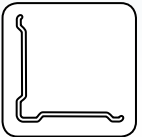

1111208570

IL KIT CONTIENE

- 8 montanti da mm 960
- 5 piani da mm 1000x400 rinforzati
- 40 bulloni
- 4 piedini in PVC



COLORI DISPONIBILI



grigio ral 7038
art. B200G



bianco ral 9003
art. B200B



giallo ral 1018
art. B200Y



nero ral 9004
art. B200N



rosso ral 3020
art. B200R





IL KIT CONTIENE

- 4 montanti da mm 1500
- 4 piani da mm 750x300
- 40 bulloni
- 4 piedini in pvc

Kg
160

**CAPACITÀ MASSIMA
DI CARICO**

Kg
40

PORTATA PER PIANO
peso distribuito

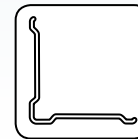

COLORI DISPONIBILI



grigio ral 7038
art. B250G



bianco ral 9003
art. B250B



giallo ral 1018
art. B250Y



nero ral 9004
art. B250N



rosso ral 3020
art. B250R



1111208570



96
PEZZI

Kg
400

CAPACITÀ MASSIMA
DI CARICO

Kg
80

PORTATA PER PIANO
peso distribuito

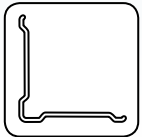

1111208570

IL KIT COMPRENDE:

- 8 montanti da mm 920
- 5 piani da mm 900x400
- 40 bulloni
- 4 piedini in PVC

COLORI DISPONIBILI

grigio ral 7038

art. **B300G**



85
PEZZI



Scaffalatura a bullone **Mini StarKit**



B350Z/SQ

IL KIT COMPRENDE:

art. **B350Z/SQ**

- 4 montanti mm 1500
- 4 piani mm 750x300
- 4 piedini in PVC
- 48 bulloni
- 4 squadrette

art. **B350Z**

- 4 montanti mm 1500
- 4 piani mm 750x300
- 4 piedini in PVC
- 32 bulloni

COLORI DISPONIBILI

zincato

Kg
160

CAPACITÀ MASSIMA
DI CARICO

Kg
40

PORTATA PER PIANO
peso distribuito

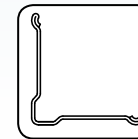

1111208570



78
PEZZI



180
PEZZI



Accessori per Kit

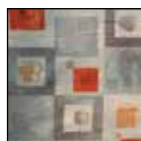

New Baby



New Estate



New Rose



New India



Nylon

Cappottine per Eurokit e Kit a bullone

articolo	descrizione	dim. LxPxH (mm)
CK100X40BA	New Baby	1000x400x1870
CK100X40ES	New Estate	1000x400x1870
CK100X40IN	New India	1000x400x1870
CK100X40RO	New Rose	1000x400x1870
CMK75X30BA	New Baby	750x300x1500
CMK75X30ES	New Estate	750x300x1500
CMK75X30IN	New India	750x300x1500
CMK75X30RO	New Rose	750x300x1500
KIS100X40Z	Serra Nylon	1000x400x1870



Fiori



Geometrica

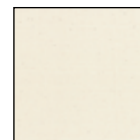

Panna



Giallo



Nylon

Cappottine per Arredokit

articolo	descrizione	dim. LxPxH (mm)
LB1-100F1	Fiori	1000x400x1800
LB1-100F2	Geometrica	1000x400x1800
LB1-100PA	Panna	1000x400x1800
LB1-100YE	Giallo	1000x400x1800
LB1-100TR	Nylon	1000x400x1800

Accessori per Kit

solo per scaffali da 1000x400

Cesti in filo nero

	articolo	descrizione	dim. LxP (mm)
1	AK100	cesto piano	950x31 ø3
2	AK105	cesto inclinato	850x28 ø3

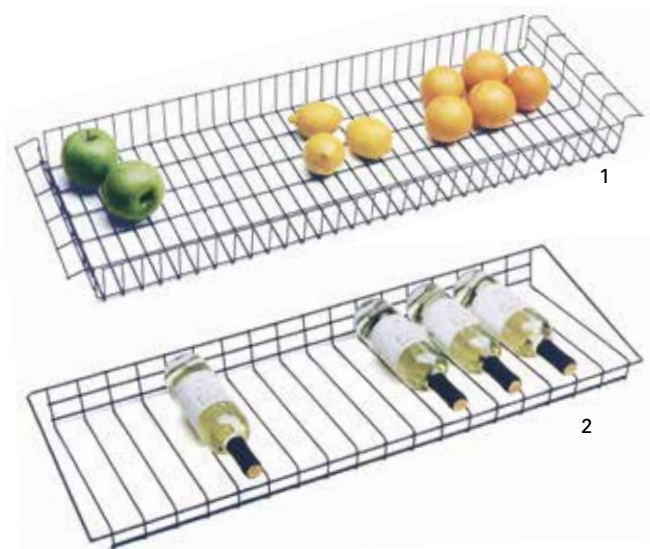

Pannello forato

Per scaffale e a muro con ganci in PVC. Colore nero

articolo	dim. (mm)
AK110	360x800h



Applicazione a muro



Ganci



	articolo	descrizione
A	AK115	coppia gancio laterale multiuso
B	AK120	*coppia supporti per capi appesi

* Non può essere utilizzato sull'articolo Arredokit ed Eurokit zincato

Serie a Bullone

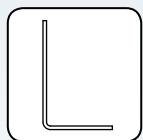
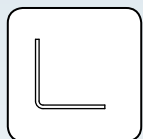

Colori disponibili:

grigio ral 7038

zincato



mm 35
mm 35
spessore 18/10

Angolare 35x35

articolo		dim. mm
grigio	zincato	
B01	B01Z	1000x35x35
B02	B02Z	1500x35x35
B03	B03Z	2000x35x35
B04	B04Z	2500x35x35
B05	B05Z	3000x35x35

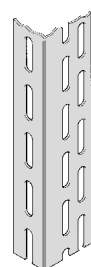

mm 35
mm 55
spessore 18/10

Angolare 55x35

articolo		dim. mm
grigio	zincato	
B06	B06Z	1000x55x35
B07	B07Z	1500x55x35
B08	B08Z	2000x55x35
B09	B09Z	2500x55x35
B10	B10Z	3000x55x35



Bullone zincato

n. 8 pezzi per piano

articolo	dim. (mm)
B100	M8x14

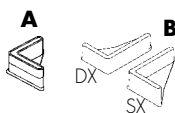

Piedino in PVC

	articolo	dim. (mm)
A	B101	35x35
B	B102	55x35



Piedino in acciaio

articolo	dim. (mm)
B104	55x55

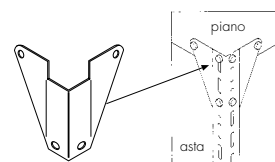

Squadretta

articolo
B103

da utilizzare in casi particolari

Piano



Attenzione!

Tutti i piani sono compatibili per le scaffalature di nostra produzione A BULLONE, LB1 e LB6 vedi pagina 19

Scaffalatura a gancio Montaggio rapido

Serie LB1



Colori disponibili:

grigio ral 7038

zincato



Traversino LB1

articolo		dimensioni (mm)
grigio	zincato	
G185	G185Z	300
G186	G186Z	400
G187	G187Z	500
G188	G188Z	600



PVC

Piedino per montante LB1

articolo	descrizione
G202	in PVC



Gancio LB1 - LB6 4 pezzi per piano

articolo	descrizione
G200	zincato

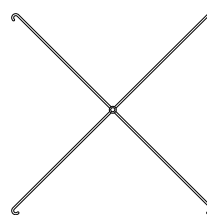

Crociera LB1 zincata

1 pezzo per campata

articolo	dimensioni (mm)
G206/01Z	per piano 600 mm
G206/02Z	per piano 800 mm
G206/03Z	per piano 1000 mm
G206/04Z	per piano 1200 mm

Piano

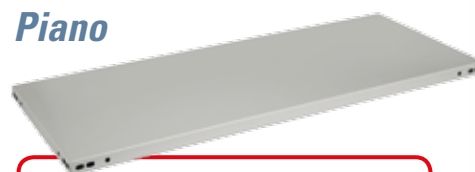

Attenzione!

Tutti i piani sono compatibili per le scaffalature di nostra produzione
A BULLONE, LB1 e LB6
vedi pagina 19

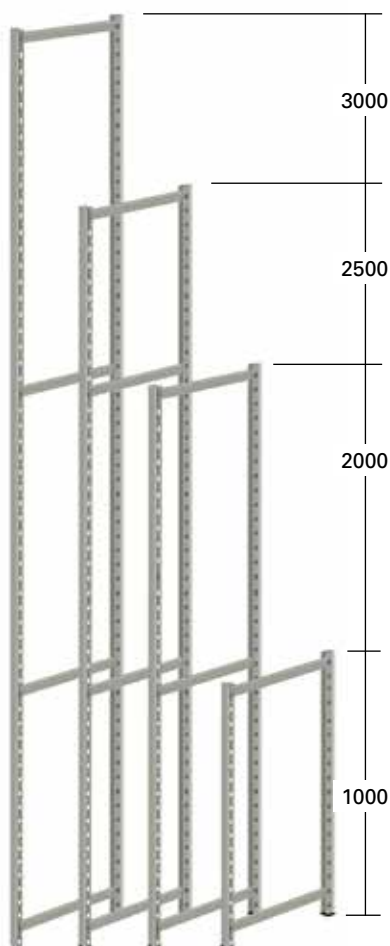
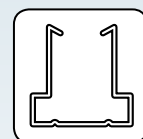

Schema montaggio fiancate composto da:

- 2 montanti
- 2 piedini
- Nr. variabile traversini come schema
- Portata massima Kg 1500

Montante LB1

articolo		dim. (mm)
grigio	zincato	
G770	G770Z	1000
G772	G772Z	2000
G774	G774Z	2500
G775	G775Z	3000

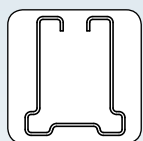

Colori disponibili:

grigio ral 7038

zincato

Colori a richiesta:

con sovrapprezzo

azzurro ral 5015

giallo ral 1033

rosso ral 3020

bianco ral 9003

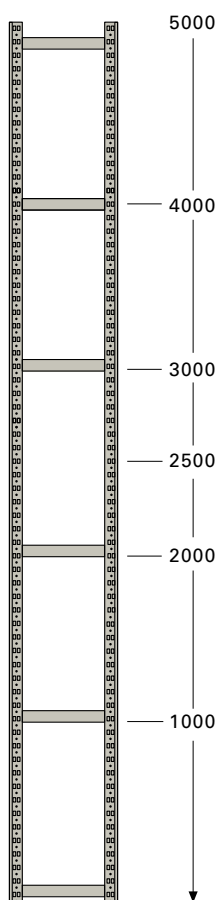

— 300
— 400
— 500
— 600
profondità mm

Schema montaggio fiancate composto da:

- 2 montanti
- 2 piedini,
- Nr. variabile traversini come schema
- Passo mm 50
- Portata massima Kg 4000

Montante

articolo		altezza (mm)	traversini
grigio	zincato		
G750	G750Z	995	2
G752	G752Z	1995	3
G754	G754Z	2495	3
G756	G756Z	2995	4
G758	G758Z	3995	5
G759	G759Z	4995	6

Traversino

articolo		per piano da (mm)
grigio	zincato	
G180V	G180Z	300
G181V	G181Z	400
G182V	G182Z	500
G183V	G183Z	600

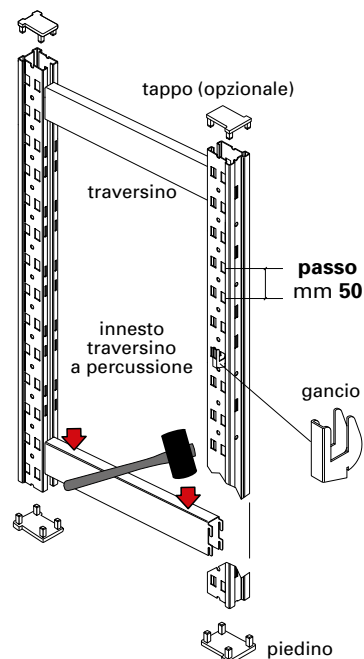

Gancio zincato

4 pezzi per piano

articolo G200

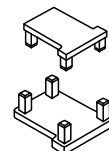

Piedino/tappo in PVC

articolo G203

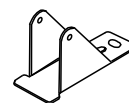

Piedino in ferro zincato

(comprensivo di vite TCCE M6x45)

articolo G204

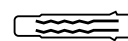

Tassello in nylon M8x60

per piedino in ferro fissaggio a pavimento

articolo G201N

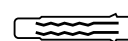

Tassello in nylon

per fissaggio a muro

articolo G202N

Piani per scaffalatura bullone, LB1 e LB6

Piano

articolo		dim. (mm)	rinforzi	portata (kg)	pezzi per pallet	pallet mm LxPxH
grigio	zincato					
BG30	G26	600x300	-	100	315	1200x1000x2250
BG31	G27	600x400	-	100	270	1200x1000x2550
BG32	G28	600x500	1	150	180	1200x1000x2150
BG33	G29	600x600	2	180	135	1200x1000x1950
BG18	G60	700x300	-	100	315	1200x1000x2250
BG19	G61	700x400	-	100	270	1200x1000x2550
BG20	G62	700x500	1	150	180	1200x1000x2150
BG21	G63	700x600	2	180	135	1200x1000x1950
BG01	G30	800x300	-	100	280	1200x1000x2250
BG38	G31	800x300	1	130	280	1200x1000x2250
BG02	G32	800x400	-	100	240	1200x1000x2550
BG03	G33	800x400	1	150	240	1200x1000x2550
BG04	G34	800x500	1	150	160	1200x1000x2150
BG05	G35	800x600	2	180	120	1200x1000x1950
BG34	G64	900x300	-	80	245	1200x1000x2250
BG35	G65	900x400	1	150	210	1200x1000x2550
BG36	G66	900x500	1	150	140	1200x1000x2150
BG37	G67	900x600	2	180	105	1200x1000x1950
BG06	G36	1000x300	-	80	245	1200x1200x2250
BG07	G37	1000x300	1	130	245	1200x1200x2250
BG08	G38	1000x400	1	150	210	1200x1200x2550
BG09	G39	1000x500	1	150	140	1200x1200x2150
BG10	G40	1000x500	2	180	140	1200x1200x2150
BG11	G41	1000x600	2	180	105	1200x1200x1950
BG12	G42	1200x300	-	80	245	1200x1200x2250
BG13	G43	1200x300	1	130	245	1200x1200x2250
BG14	G44	1200x400	1	130	175	1200x1200x2150
BG15	G45	1200x500	1	130	140	1200x1200x2150
BG16	G46	1200x500	2	150	140	1200x1200x2150
-	G50	1200x500	3	230	140	1200x1200x2150
BG17	G47	1200x600	2	150	105	1200x1200x1950
-	G51	1200x600	3	230	105	1200x1200x1950
BG22	G52	1500x300	2	200	175	1500x1000x1650
BG23	G53	1500x400	2	200	140	1500x1000x1750
BG24	G54	1500x500	3	180	105	1500x1000x1650
BG25	G55	1500x600	3	180	105	1500x1000x1950

Divisorio squadra mobile

articolo	dim. (mm)
grigio	
G640/01V	300x200h
G640/02V	400x200h
G640/03V	500x200h
G640/04V	600x200h
G640/10V	300x300h
G640/11V	400x300h
G640/12V	500x300h
G640/13V	600x300h

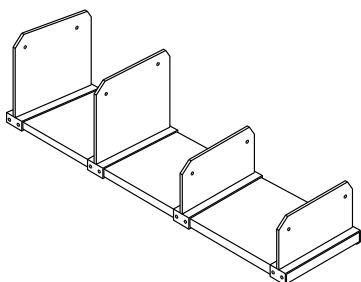

Portata piano da 80 Kg a 230 Kg

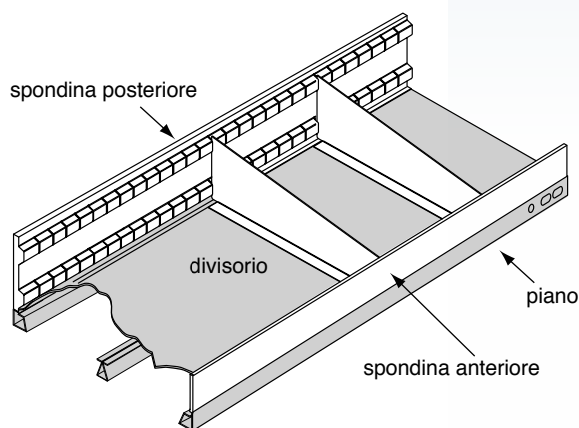
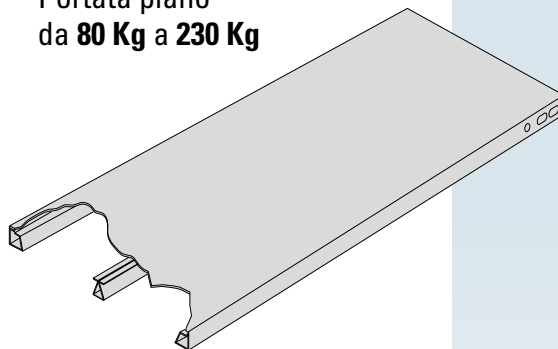

Vasche su piano

articolo		descrizione	dim. (mm)
grigio	zincato		
BG102	BG112	spondina anteriore	800x100h
BG103	BG113	spondina posteriore	800x200h
BG100	BG110	spondina anteriore	1000x100h
BG101	BG111	spondina posteriore	1000x200h
BG104	BG114	spondina anteriore	1200x100h
BG105	BG115	spondina posteriore	1200x200h
BG106	BG116	spondina anteriore	1500x100h
BG107	BG117	spondina posteriore	1500x200h
-	BG120	divisorio	300
-	BG121	divisorio	400
-	BG122	divisorio	500
-	BG123	divisorio	600

Avant LB6 accessoriato



Legenda

- 1 Fiancata
- 2 Piano
- 3 Tamponamento schiena
- 4 Tamponamento fiancate
- 5 Divisorio a squadra mobile
- 6 Divisorio a cremagliera
- 7 Spondina anteriore
- 8 Spondina posteriore
- 9 Porta
- 10 Guide per contenitori
- 11 Contenitori in plastica

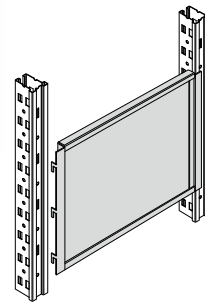

Tamponamento interno fiancata

Con pieghe orizzontali in lamiera chiusa.
Foro quadro su richiesta

articolo		dim. (mm)
grigio	zincato	
G555/01V	G555/01Z	880x300
G555/02V	G555/02Z	880x400
G555/03V	G555/03Z	880x500
G555/04V	G555/04Z	880x600
G560/01V	G560/01Z	980x300
G560/02V	G560/02Z	980x400
G560/03V	G560/03Z	980x500
G560/04V	G560/04Z	980x600
G565/01V	G565/01Z	1080x300
G565/02V	G565/02Z	1080x400
G565/03V	G565/03Z	1080x500
G565/04V	G565/04Z	1080x600
G570/01V	G570/01Z	1180x300
G570/02V	G570/02Z	1180x400
G570/03V	G570/03Z	1180x500
G570/04V	G570/04Z	1180x600
G580/01V	G580/01Z	1380x300
G580/02V	G580/02Z	1380x400
G580/03V	G580/03Z	1380x500
G580/04V	G580/04Z	1380x600

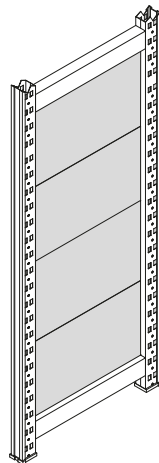

Tamponamento schiena

in lamiera chiusa. Foro quadro su richiesta

articolo		dim. (mm)
grigio	zincato	
G605/02V	G605/02Z	800x500h
G605/04V	G605/04Z	1000x500h
G605/06V	G605/06Z	1200x500h
G605/08V	G605/08Z	1500x500H

Schema di montaggio fiancate e predisposizione tamponamenti

Rispettare rigorosamente le quote e il numero dei traversini indicati nello schema

La quota in rosso corrisponde alla misura del tamponamento interno

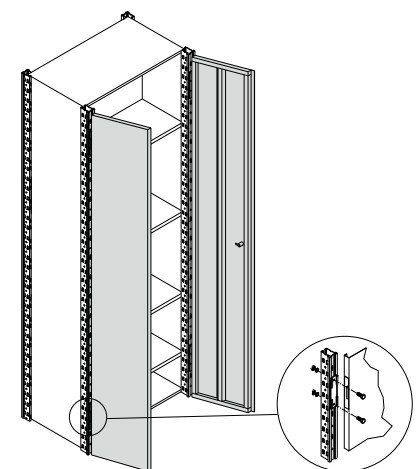

Porta metallica

a 2 ante con serratura

articolo		dim. (mm)
grigio	zincato	
G676V	G676Z	1000x1000h
G675V	G675Z	1000x2000h

1) Corrente di irrigidimento

articolo		dim. (mm)
grigio	zincato	
G205/01V	G205/01Z	800
G205/02V	G205/02Z	1000
G205/03V	G205/03Z	1200
G205/04V	G205/04Z	1500

2) Correntino portamensole

articolo		descrizione	dim. (mm)
grigio	zincato		
G650/02V	G650/02Z	portamensole	1000
G660/01V	G660/01Z	mensola	300
G660/02V	G660/02Z	mensola	400

3) Correntino portagomme per scaffale

per comporre il piano utilizzare n. 2 pezzi

articolo		dim. (mm)
grigio	zincato	
G650/01V	G650/01Z	800
G650/02V	G650/02Z	1000
G650/03V	G650/03Z	1200
G650/04V	G650/04Z	1500

4) Correntino portagomme inclinato per impianti

per comporre il piano utilizzare n. 2 pezzi

articolo		dim. (mm)
grigio	zincato	
G652/01V	G652/01Z	800
G652/02V	G652/02Z	1000
G652/03V	G652/03Z	1200
G652/04V	G652/04Z	1500

Bullone zincato per fissaggio

4 pezzi per corrente

articolo	dim. (mm)
G702	TBCE M6x25



Squadretta per fissaggio

n. 2 pezzi per barra collegamento

articolo	descrizione
G220	a "L" dx-sx zincata
G222	a "Z" dx-sx zincata

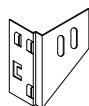

5) Traversino per tubo appendieria

articolo		dim. (mm)
grigio	zincato	
G666/01	G666/01Z	300
G666/02	G666/02Z	400
G666/03	G666/03Z	500
G666/04	G666/04Z	600

6) Barra appendieria cromata

articolo	dim. (mm)
G665/01	800
G665/02	1000
G665/03	1200

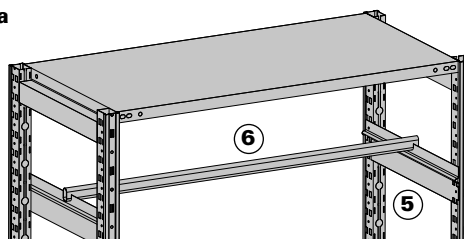

Schema di irrigidimento per batterie con altezza superiore a mm 2000

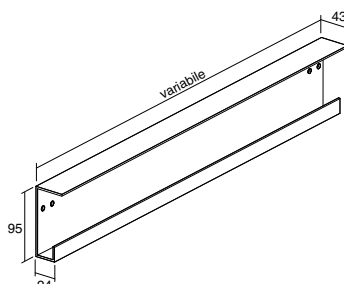
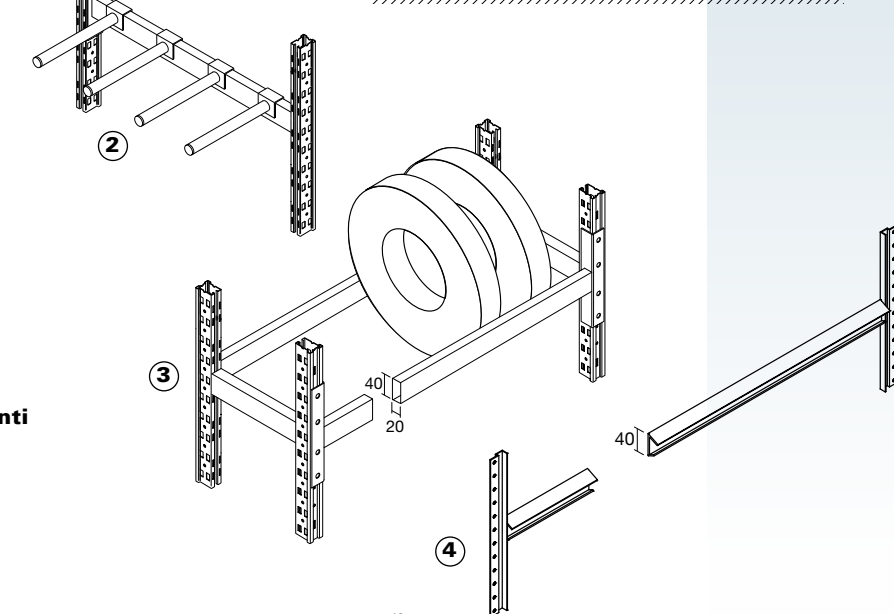
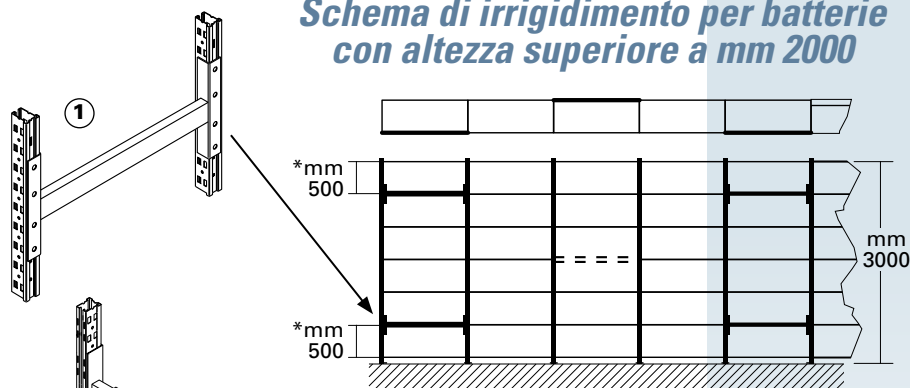

Barra collegamento batterie

articolo		dimensione (mm)
grigio	zincato	
G210V	G210Z	95x43x variabile

Bullone zincato per fissaggio

n. 4 pezzi per barra collegamento

articolo	dim. (mm)
B100	TE M8x14



Bullone zincato per fissaggio

batterie contrapposte

articolo	dim. (mm)
G702	TBCE M6x25

Avant LB6 per cassette

Scaffalatura LB6 ad incastro per cassette

Adatta all'inserimento delle cassette in polipropilene da mm 600x400. Disponibile in versione zincata.

La coppia di guide ha una portata di Kg. 50 e queste possono essere regolate in altezza con passo da 50 mm.

Lo scaffale viene composto da un modulo base + i moduli seguenti. Le coppie di guide vanno calcolate in base alla necessità dividendo "h utile" per il "passo guide" dei contenitori.

Disponibile anche nella versione per contenitori in metallo.

Scaffale per cassette da mm 600x400

articolo	descrizione	alt. utile (mm)
G910BZ	modulo base da mm 1000 h	800
G910SZ	modulo seguente da mm 1000 h	800
G915BZ	modulo base da mm 2000 h	1800
G915SZ	modulo seguente da mm 2000 h	1800
G960Z	coppia guide da 600 mm	-

Scaffale per cassette da mm 400x300

articolo	descrizione	alt. utile (mm)
G900BZ	modulo base da mm 1000 h	800
G900SZ	modulo seguente da mm 1000 h	800
G905BZ	modulo base da mm 2000 h	1800
G905SZ	modulo seguente da mm 2000 h	1800
G940Z	coppia guide da 400 mm	-



Cassette in plastica da mm 600x400

articolo	dim. P x L x H (mm)	passo guide (mm)
G961	600x400x75	100
G962	600x400x120	150
G963	600x400x150	200
G964	600x400x170	200
G965	600x400x216	250
G966	600x400x230	250
G967	600x400x280	300
G968	600x400x340	350
G969	600x400x420	450

Cassette in plastica da mm 400x300

articolo	dim. P x L x H (mm)	passo guide (mm)
G941	400x300x120	150
G942	400x300x170	200
G943	400x300x220	250
G944	400x300x320	350

Cassettiere per piano

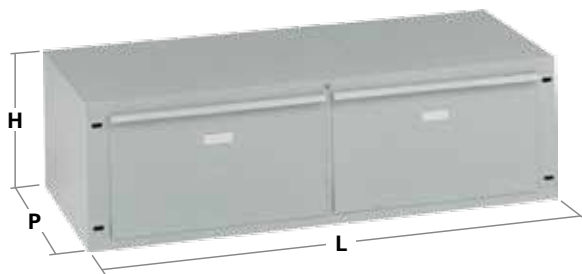

Cassettiera 2 cassetti dotati di due divisori per cassetto

articolo grigio	dim. esterne LxPxH (mm)	dim. utili cass. LxPxH (mm)
063/24	1000x400x300	410x350x230
063/25	1000x500x300	410x450x230



Cassettiera 4 cassetti dotati di due divisori per cassetto

articolo grigio	dim. esterne LxPxH (mm)	dim. utili cass. LxPxH (mm)
063/44	1000x400x300	410x350x100
063/45	1000x500x300	410x450x100



Cassettiera 6 cassetti dotati di due divisori per cassetto

articolo grigio	dim. esterne LxPxH (mm)	dim. utili cass. LxPxH (mm)
063/64	1000x400x300	256x350x100
063/65	1000x500x300	256x450x100



Cassettiera 8 cassetti dotati di due divisori per cassetto

articolo grigio	dim. esterne LxPxH (mm)	dim. utili cass. LxPxH (mm)
063/84	1000x400x300	178x350x100
063/85	1000x500x300	178x450x100



Cassettiera 12 cassetti dotati di due divisori per cassetto

articolo grigio	dim. esterne LxPxH (mm)	dim. utili cass. LxPxH (mm)
063/124	1000x400x300	101x350x100
063/124	1000x500x300	101x450x100



Divisori supplementari zincati per cassetto

articolo grigio	descrizione	dim. LxH (mm)
063/2DIV	per cass. a 2 cassetti	410x196h
063/4DIV	per cass. a 4 cassetti	410x90h
063/6DIV	per cass. a 6 cassetti	256x95h
063/8DIV	per cass. a 8 cassetti	178x95h
063/12DIV	per cass. a 12 cassetti	101x95h

MAXI 80

APIANI

PREMONTATO
Armadio Componibile

Kg
50

PORTATA PER PIANO
peso distribuito



PREMONTATO



MONTAGGIO
RAPIDO 10 min



1111208535

CARATTERISTICHE:

- Premontato
- Acciaio verniciato
- 4 piani
- Serratura con chiave

grigio ral 7038

art. **MAXI80G**



MONTAGGIO MAXI E MINI - FACILE E VELOCE



PREMONTATO
Armadio Componibile

MINI 80

A PIANI



CARATTERISTICHE:

- Premontato
- Acciaio verniciato
- 2 piani
- Serratura con chiave

grigio ral 7038

art. **MINI80G**

Kg
50

PORTATA PER PIANO
peso distribuito



PREMONTATO



MONTAGGIO
RAPIDO 10 min



111208535



Piano regolabile in altezza



Serratura con chiave

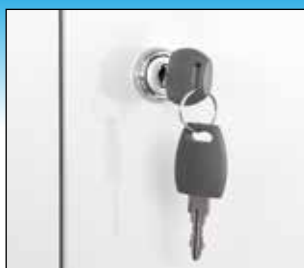

Premontato



Piedino regolabile



MAXI 60

APIANI

PREMONTATO

Armadio Componibile

Kg
50

PORTATA PER PIANO
peso distribuito



PREMONTATO



MONTAGGIO
RAPIDO 10 min



1111208535

CARATTERISTICHE:

- Premontato
- Acciaio verniciato
- 4 piani
- Serratura con chiave

grigio ral 7038

art. **MAXI60G**



MONTAGGIO MAXI - FACILE E VELOCE



PREMONTATO
Armadio Componibile

MAXI 60

PORTASCOPE



CARATTERISTICHE:

- Premontato
- Acciaio verniciato
- 4 piani
- Serratura con chiave

grigio ral 7038

art. MAXI60PSG

Kg
50

PORTATA PER PIANO
peso distribuito



PREMONTATO



MONTAGGIO
RAPIDO 10 min



1111208535



Piano regolabile in altezza

Serratura con chiave

Premontato

Piedino regolabile



MINI 60

APIANI

PREMONTATO
Armadio Componibile

Kg
50

PORTATA PER PIANO
peso distribuito



PREMONTATO



MONTAGGIO
RAPIDO 10 min



1111208535

CARATTERISTICHE:

- Premontato
- Acciaio verniciato
- 2 piani
- Serratura con chiave

grigio ral 7038

art. **MINI60G**



MONTAGGIO MINI - FACILE E RAPIDO



PREMONTATO
Armadio Componibile

BRICO 1

APIANI



CARATTERISTICHE:

- Premontato
- Acciaio verniciato
- 4 piani
- Serratura con chiave

grigio ral 7038

art. **BRIC01G**

Kg
50

PORTATA PER PIANO
 peso distribuito



PREMONTATO



MONTAGGIO
RAPIDO 10 min



111208535



Piano regolabile in altezza

Serratura con chiave

Premontato

Piedino regolabile

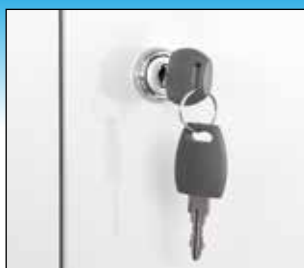

BRICO 7

SPOGLIATOIO

PREMONTATO

Armadio Componibile

Kg
50

PORTATA PER PIANO
peso distribuito



PREMONTATO



MONTAGGIO
RAPIDO 10 min



1111208535



Tettuccio inclinato
su richiesta
mm 430x440x16,5h
grigio ral 7038

CARATTERISTICHE:

- Premontato
- Acciaio verniciato
- 1 piano
- 1 divisorio
- Serratura con chiave

grigio ral 7038

art. **BRIC07G**



MONTAGGIO BRICO - FACILE E RAPIDO



PREMONTATO
Armadio Componibile

BRICO 9

PORTASCOPE



CARATTERISTICHE:

- Premontato
- Acciaio verniciato
- 4 piani
- Serratura con chiave

grigio ral 7038

art. **BRIC09G**

Kg
50

PORTATA PER PIANO
peso distribuito



PREMONTATO



MONTAGGIO
RAPIDO 10 min



111208535



Piano regolabile in altezza



Serratura con chiave

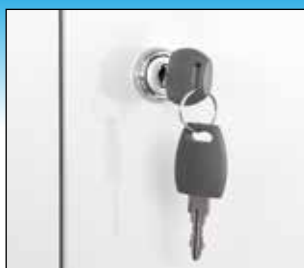

Premontato



Piedino regolabile



Banco "Fai da Te"

Banco componibile in lamiera da 15/10 con sottopiano.
Cassetto di servizio con chiave.

articolo	dim. LxPxH (mm)
grigio / rosso	1000x700x920
050/100GR	

grigio ral 7038

rosso ral 3020



Set pannelli

Optional: (2 pannelli, supporti e n. 52 ganci in nylon)

articolo	dim. LxH (mm)
grigio / rosso	980x970h
050/KIT	

Pannelli forati

Realizzati in lamiera con fori e asole, dimensioni mm 980x480.
Adatto per ganci in nylon o in metallo

grigio ral 7038

blu ral 5010

bianco ral 9003

rosso ral 3020



Ganci in Nylon

Blister

articolo	descrizione	pezzi
BG061/01F	corto dritto	12
BG061/02G	lungo dritto	8
BG061/04I	pinza	8
BG061/05L	anello piccolo	8
BG061/06M	anello grande	8
BG061/07O	obliquo	8
BG061/08P	uncino	8

Confezione in scatola 100 pz.

Dimensioni scatola cm 12x22x8h

articolo	descrizione
SG061/01F	corto dritto
SG061/02G	lungo dritto
SG061/04I	pinza
SG061/05L	anello piccolo
SG061/06M	anello grande
SG061/07O	obliquo
SG061/08P	uncino

articolo senza ganci			
grigio	blu	bianco	rosso
054	054A	054B	054R
6 pezzi per imballo			

articolo con 52 ganci			
grigio	blu	bianco	rosso
054GKIT	054AKIT	054BKIT	054RKIT
1 pezzo per imballo			

Banchi da lavoro

Banchi da lavoro M3

Struttura a gambe saldate a ponte con piano di lavoro in lamiera spessore 30/10 o con piano di lavoro in faggio multistrato spessore 40mm. Sottopiano in lamiera 20/10.

grigio ral 7038



articolo	dim. LxPxH (mm)
Z3ME00047	1200x750x850



articolo	dim. LxPxH (mm)
Z3ME00050	1200x750x850



articolo	dim. LxPxH (mm)
Z3ME00048	1500x750x850



articolo	dim. LxPxH (mm)
Z3ME00051	1500x750x850



articolo	dim. LxPxH (mm)
Z3ME00049	2000x750x850



articolo	dim. LxPxH (mm)
Z3ME00052	2000x750x850

Cassettiere per banchi M3

Cassetti per banchi da lavoro in lamiera, scorrimento su guide con cuscinetti. Con serratura. Colore grigio RAL 7038.

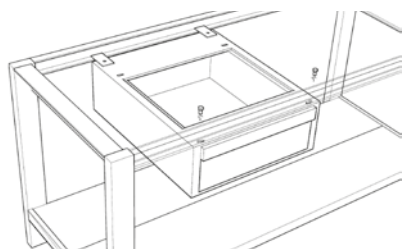

articolo	dim. LxPxH (mm)	descrizione
Z3ME00068	550x665x205	1 cassetto h140



articolo	dim. LxPxH (mm)	descrizione
Z3ME00069	550x665x205	2 cassetti h70

Prodotti per l'industria

Portapallet



Cantilever



Coils Block



Soppalchi



Avant LB6



Ricambisystem





AZIENDA CERTIFICATA

36027 Rosà (VI) - Italy
Via Manzoni, 32
Tel. +39 0424 581079 - Fax +39 0424 581312
info@bizzottoscaffalature.it
www.bizzottoscaffalature.it

